



Helix Permanent Jewelry Welder

User Guide

Prior to utilizing the product
please thoroughly review this manual.

PEPE[®] TOOLS

Manufactured by Pepetools

support@pepetools.com

1-405-745-4054

pepetools.com



ATTENTION:

**Read the Safety Guide before operating this welder!
Operator assumes all liability.**

Safety Guide

1. Ensure the welding machine is operated in a well-ventilated area, free from flammable materials and combustible gases. Avoid use in damp environments to prevent damage or short circuits in electrical components.
2. Prioritize electrical safety by grounding the welding machine and using a standard power outlet. Refrain from modifying the power cord or damaging the plug. Disconnect power when not in use to save energy and prevent accidents.
3. Wear appropriate personal protective equipment, such as safety glasses, gloves, and suitable attire, during machine operation to reduce the risk of injury from sparks or splatter.
4. Familiarize yourself with the operating procedures by thoroughly reading the instruction manual. Follow the manual's guidelines for starting, operating, and shutting down the welding machine to prevent misuse.
5. Conduct regular inspections and maintenance checks on the welding machine, including power cords, control systems, and electrodes, to ensure proper functionality and extend equipment lifespan.
6. Restrict the use of the welding machine to trained personnel familiar with operating procedures. Prohibit children and untrained individuals from using the equipment.
7. Incorporate clear warning signs in the manual to remind users of safety precautions, including potential fire hazards, electric shock, and other dangers.

These guidelines are essential to ensure the secure and proper use of the welding machine.

Warning



1. Avoid disassembling the body.
2. Refrain from exposing it to fire, and steer clear of usage or storage in high temperatures.
3. Do not try to modify or repair this product independently.
4. Keep the product away from water and prevent liquids from entering.

Specification

Function	Direction
Display	7 Segment Display
Power	110 / 220V
Power switch	48V / 2.5A
Interface	
RJ45	Shade control cable insert
Gas port	Pipe diameter Ø1/4"
DC jack	Plug female ID Ø2.5mm , OD Ø5.5mm (2.5 A / 48 V)
Weld probe	<ul style="list-style-type: none"> ■ Weld Negative Pole ■ Ø20 x H175 mm
Weld jack	<ul style="list-style-type: none"> ■ Weld Positive Pole ■ Ø4mm banana plug female
Others	
Dimensions	W135 x D122 x H90 mm
Weight	1.26KG ± 5%
Material	Aluminum

Contents

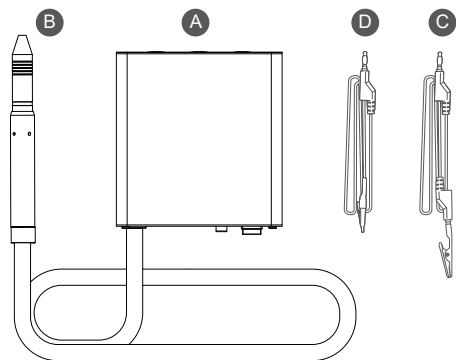

- A. Helix Permanent Jewelry Welder
- B. Stylus Handpiece
- C. Alligator Clip with Banana Plug, Stackable (Plug in Multiple Leads)
- D. Precision Copper Alligator Clip

i If You Purchased the Darkening Screen Stand

- E. Darkening Screen Stand with RJ45 Cable

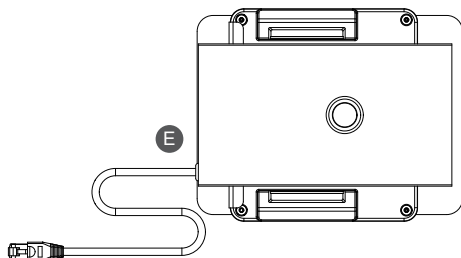

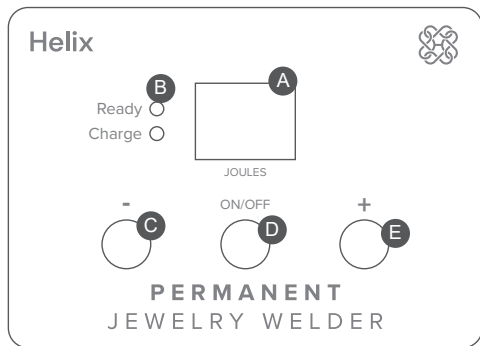

Front Panel

- A. Display
- B. Indicator (Ready/Charge)
- C. Decrease Power (joules)
- D. ON/OFF (Switch to welding standby mode)
- E. Increase Power (joules)

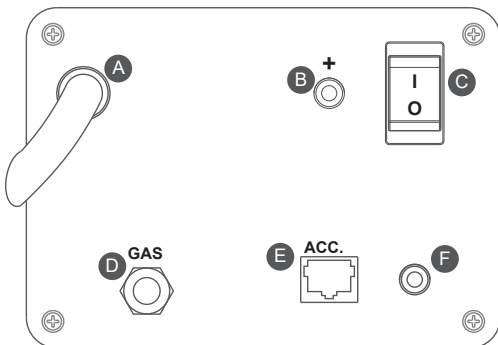

Back Interface

- A. Stylus Tube
- B. Grounding Port
- C. Power Switch
- D. Argon Gas Port
- E. Darkening Screen Port (RJ45)
- F. Power Port

Welder Setup and Operating Instructions

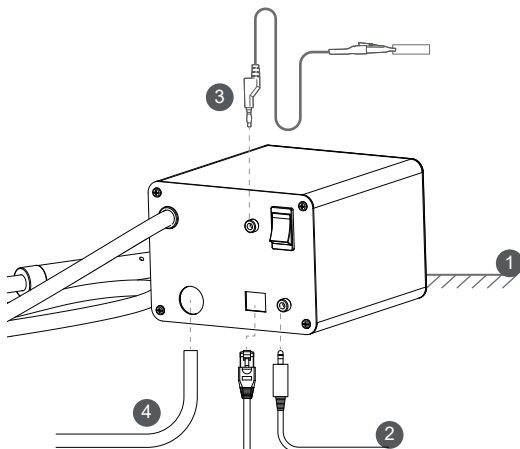

Prior-Welding Preparations

1. Position the welding machine on a level and sturdy work surface.
2. Insert the power cord slot into the AC power port and connect the plug to the AC power source (compatible with dual voltage inputs).
3. Place the ground wire terminal into the grounding port, using the other end of the alligator clip to secure it to the workpiece intended for welding.
4. If desired, insert the argon gas tube into the argon gas port (optional, as the machine operates effectively even without it).

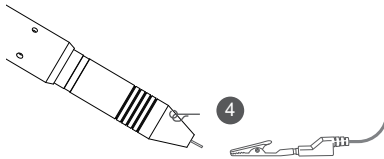
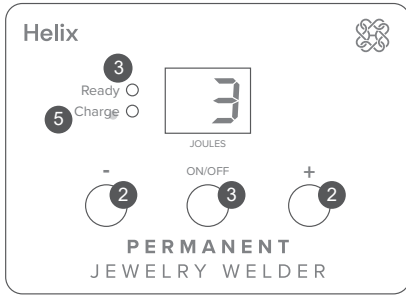

Welding Operating Instructions

1. Turn on the power switch.
2. Use the +/- button to set the desired power level (30 settings ranging from 1 - 30 joules).
3. Press the ON/OFF button; the green "ready" indicator signifies the machine is in welding mode.
4. Weld by bringing the tip of the Stylus handpiece in contact with the workpiece. Secure the handpiece in the holder if needed, utilizing optional accessories.
5. After welding, the "Charge" indicator turns red, signifying a brief recharging period. Wait for the "Ready" indicator to turn green before proceeding to the next welding operation.



You can adjust the power level whenever the 'Ready' indicator is green.

Electrode Rod Setup Instructions

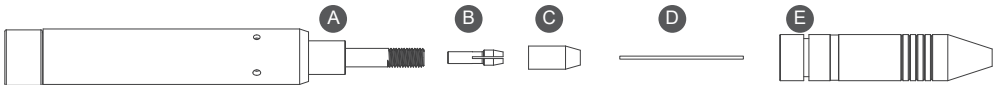

A. Stylus Shaft

B. Brass Collet

C. Collet Cap

D. Electrode Rod

E. Stylus Cap

Assemble/Exchange the electrode rod in the following steps:

1. Detach the stylus cap directly from the stylus handpiece.
2. Unscrew the collet cap counterclockwise until the first electrode rod can be installed or the old electrode rod can be removed.
3. Insert the new electrode rod into the brass collet and adjust the rod to the appropriate length.
4. Tighten the brass collet by turning collet cap clockwise until the electrode rod fits securely.
5. Reattach the stylus cap onto the stylus handpiece.



1. Ensure that the electrode rods extend beyond the stylus cap by 1/8 to 1/4 inch (3.175 to 6.35mm).
2. After several uses, oxidation may develop on the electrode rods. If welding performance diminishes, it is advisable to delicately sand the rods using 1000-grit sponge sandpaper.

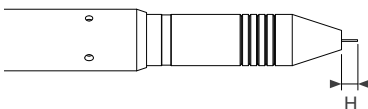

Darkening Screen Stand Operating Instructions

When the Darkening Screen Stand is acquired and linked to the welding machine, operators gain clear visibility of the workpiece through the window. The lens automatically darkens during welding, minimizing the risk of eye damage from flashes.

Contents Includes the following:

1. The darkening screen with RJ45 cable
2. Adjustable stand with foldable design

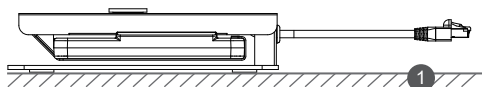

1. Position the welding machine stand on a flat and stable work surface.

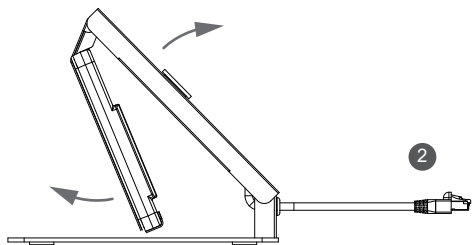

2. Unfold the stand and adjust it to the preferred angle.

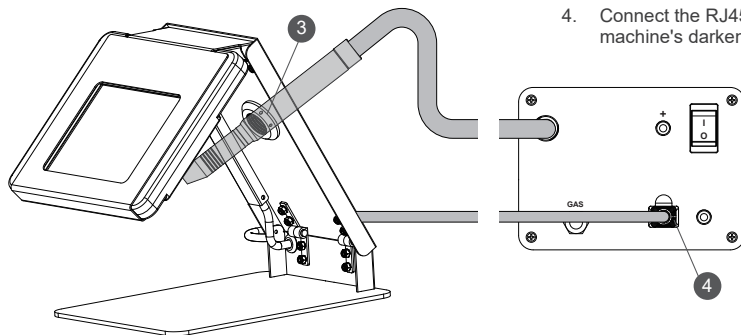

3. Secure the Stylus handpiece in the holder.
4. Connect the RJ45 connector to the welding machine's darkening screen port.

The electrode rod may fail to rebound after use due to the shaft, collet, and cap becoming stuck.

During operation, avoid over-rotating the stylus shaft or excessively stretching the stylus tube, as this may lead to the inner wire becoming twisted or tense. Such conditions can hinder the proper rebound of the electrode rod following welding.

Troubleshooting Steps:

1. Detach the stylus cap and electrode rod.

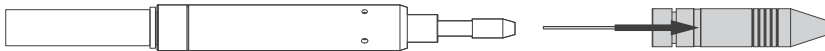

2. Push down on the end grommet while gently pulling the tube until the internal wire becomes slightly visible.

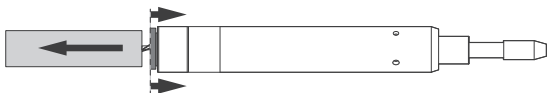

3. Grasp the tube and stylus shaft, then turn the end cap clockwise to expose the internal circuit.

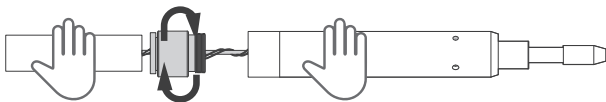

4. Adjust the stylus shaft rotation until the internal wire is straightened and no longer distorted. Next, press the collet cap to verify if it rebounds.



5. While securely holding the tube and stylus shaft, firmly rotate the end cap counterclockwise to prevent wire distortion during tightening.

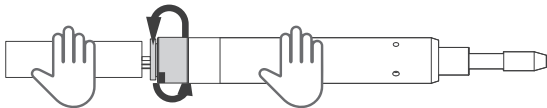

6. Push down on the end grommet while inserting the tube to its lowest position.

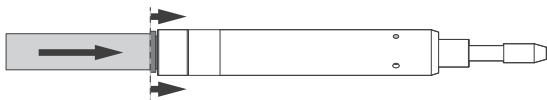

7. Reattach the electrode rod and stylus cap.

