

*BezelEase*TM

www.BezelEase.com

INSTRUCTION BOOKLET

Congratulations On Purchasing Your BezelEase™!

BezelEase™ is a precision tool engineered to help you quickly and easily create fancy, castellated or serrated bezels for your jewelry and crafts.

By following the simple instructions, you can precisely cut bezel tops and sides in 2mm, 3mm, 4mm and 6mm widths. No fumbling with gauges—each cut is calibrated and accurate, making your bezels look perfect every time.

BezelEase™ is extremely versatile and acts as a vise that secures your bezel material. The included spacers may be used singly or together to form a ledge or platform to support your bezel material and also to accommodate larger materials. They can be rotated for deeper pieces of metal. They can also be removed completely for very thin gauge metals, providing full support to the sides and avoiding distortion of the material as you cut.

For more information and instructional videos, go to BezelEase.com or search for “BezelEase” on YouTube.



Warranty

BezelEase™ is precision manufactured under strict supervision and quality assurance. We stand behind our product. If any component is defective or is broken through normal use, please contact us at **support@BezelEase.com** for return instructions. Once you send us the part, we'll promptly ship you a replacement.

What's In the Box?

- Instruction Booklet
- BezelEase™ Tool consisting of:
 - ❶ Outer Front Plate with the BezelEase™ logo and two smooth-bored holes.
 - ❷ A thick spacer plate (≈16 gauge)
 - ❸ A thin spacer plate (≈20 gauge)
 - ❹ Outer Back Plate with two threaded holes
 - ❺ Two threaded fasteners
 - ❻ A hex key (SAE 3/16)

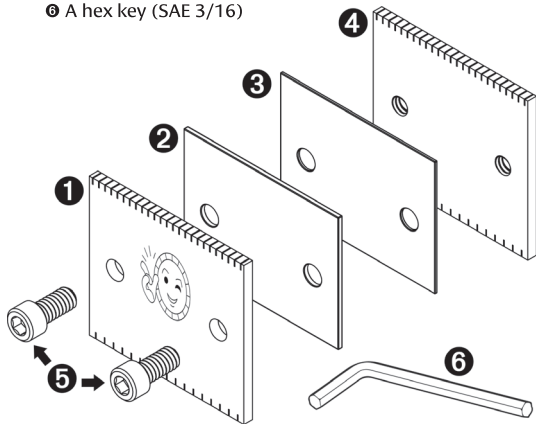

NOTE: The top of each outer plate has slots in 2 mm increments. The bottom has slots that are spaced 3 mm apart. You can create 4 or 6 millimeter slots by skipping every other slot to achieve the desired bezel dimensions.

BezelEase™ assembles into a vise that securely holds your bezel material for cutting or scoring.

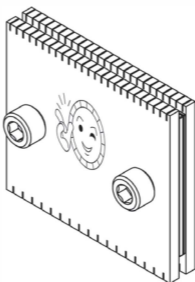

The included spacer plates may be used together, singly or not at all. When you choose to use them, they form a shelf or ledge to support your material.



WITHOUT SPACERS



BOTH SPACERS
INSERTED

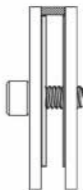

WIDE MATERIAL*

***NOTE:** For very wide materials, you may want to insert a couple of Popsicle® sticks or a small piece of wood or other material to prevent the bottom of the BezelEase™ from bowing in too much and having your bezel material pop out.

The spacers can be rotated to form a shelf that is either 2 millimeters or 8 millimeters from the top edge, depending on your needs.

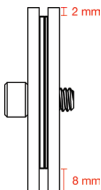

How Tall Should My Bezel Be?

The bezel angle is the slope that is cut on the side of a cabochon for a short distance above the girdle. Its purpose is to allow the bezel to be rolled or pressed down against the stone to secure it in the mount.

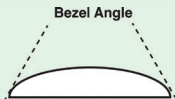

- The bezel should be tall enough to form a lip where the stone tapers in from the girdle or base.
- If your bezel is too short, the stone won't be secure and it may fall out.
- If the bezel height is too tall, you'll cover too much of the stone.

It really is a matter of personal preference and aesthetic. As a general rule, many artisans do 2/3 the height of the stone. If your bezel is too tall, you can always make it shorter; if it's too short, you'll need to start over again.

BezelEase™ Quick Start

1. Calculate the diameter of your stone. One technique is to wrap a piece of painter's tape around the girdle of the stone.

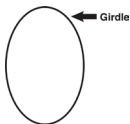

The girdle is the largest circumference or outline of the stone when viewed from directly above or below.

Cut one edge of the tape, peel it off the stone, and place it on a flat surface. Measure the length of the tape and add 10 millimeters or so to allow for adjustments.

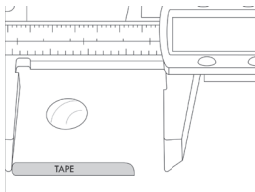

Transfer the measurement to your bezel metal.

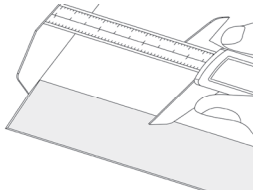

2. Measure the height of your stone using a caliper or a jeweler's scribing compass. This will help you determine the height of your bezel.

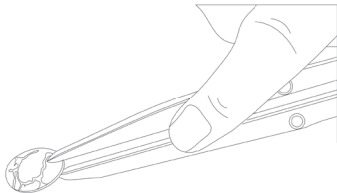

Using the scribe or a marker, mark the desired height of your bezel onto the length of the bezel material.

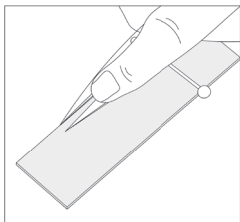

3. Cut your bezel material, then file the metal to square the piece.

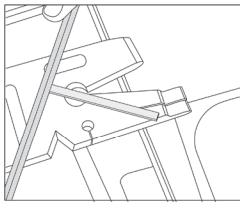

4. Decide which interval you want to cut, 2 mm or 3mm and ensure that the edges match.

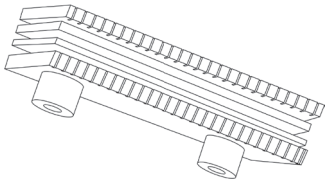

The step spacers may be used to accommodate the width of metal in the vise. One spacer is ≈ 20 gauge and the other is ≈ 16 which allows for several combinations.

5. First you'll cut the top of the bezel. Place the piece of bezel material inside the BezelEase™ and level it flush to the top edge.

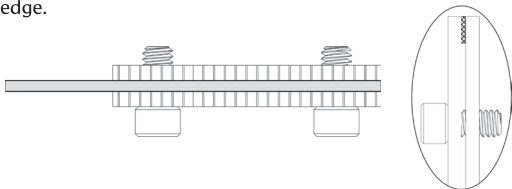

Let it overhang the end by a few millimeters so you can easily manipulate the metal.

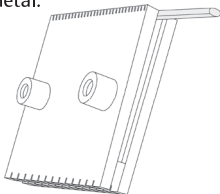

Turn the screw fasteners using your hand or the hex wrench. Tighten enough to securely hold your material, but do not over-tighten or you may distort the metal.

TIP: While the BezelEase™ can be handheld, many users find that securing it into a bench vise provides additional ease and stability.

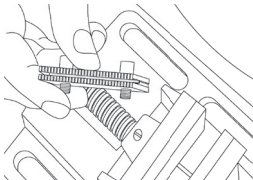

6. Use a #2 or #3 saw blade, to make your cuts. We also recommend using beeswax, BurLife®, Boelube® or another lubricant. It makes cutting easier, improves the quality of the cuts, and extends the life of your saw.

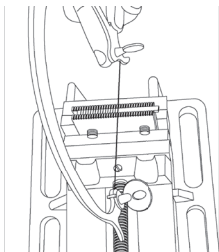

Using the precision slots, saw cut each slot to your preferred depth. Use the same number of saw strokes to achieve even depths. [NOTE: The first time you use the device, the slots may be little tight. This will smooth out after first use.]

Make your cuts carefully. Do NOT cut through the material or you will need to start over!

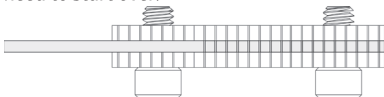

Once your first set of cuts is complete, you may need to reposition the bezel material to make additional cuts. Loosen the screw fasteners, slide the cut metal piece to the end of the vise and carefully line up the cuts with the slots.

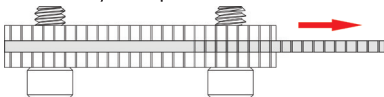

TIP: Some users place the saw into a slot to help line up the material. The more precisely you line up the previous cuts to the calibrated slots, the better your finished bezel will look.

7. When you are finished the cuts on the top, remove the material. Rotate it 90 degrees and put it back in the BezelEase. If not already inserted, you may wish to use the step spacers to form a ledge 2 millimeters from the top.

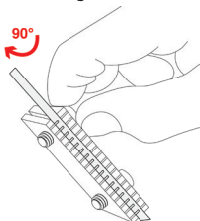

Carefully line up the cuts with the slots and tighten the screw fasteners.

It should look something like this:

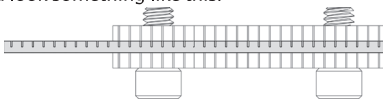

8. Remember to lubricate your saw blade. Carefully score the material to the desired depth. Two strokes is usually enough to get the side slot cut. You may want more, depending on the desired effect...but proceed slowly until you learn how to gauge the depths you want to cut. [The red marks show where the material is scored.]

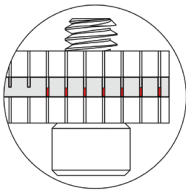

Continue with your cuts and reposition the material as needed. When the cuts are complete, remove your completed bezel strip from the BezelEase™.

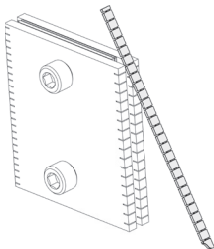

With a bit of practice, you'll create perfect bezels every time!

Now you're familiar with how to use BezelEase. The rest of this project relies on standard jewelry-making techniques.

9. Remove your cut bezel material. Anneal the metal and quench.

10. Carefully, wrap your bezel around the stone and cut to fit.

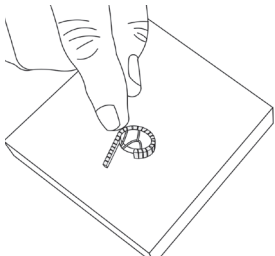

File and solder the bezel ends and clean off the excess solder.

11. Sand the soldered bezel until the top and bottom edges are flat and square.

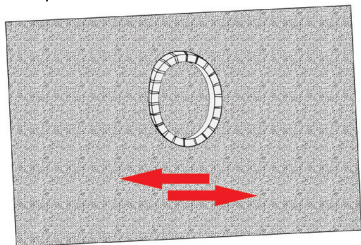

12. Adjust the bezel until the stone comfortably fits inside.

13. Solder the bezel to a backing plate, saw off any excess perimeter, file and sand.

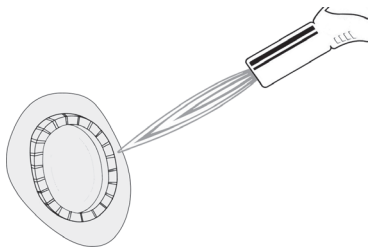

NOTE: If you want the slots to continue through the base plate, finish by cutting slots on the base plate to match the slots on your bezel.

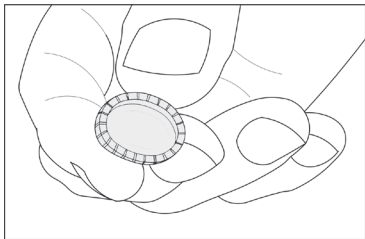

If you are putting a fancy trim such as twisted wires or beads around the base that hide the seam, then cutting the additional slots is not necessary.

14. Test fit the stone in the bezel. Use a file or handpiece and burr, if necessary, to widen the bezel so the stone fits easily.

TIP: Prior to test fitting the stone, insert a length of dental floss or thin wire to help you remove the stone afterwards.

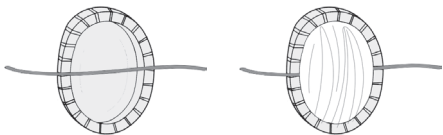

15. Complete your setting by adding bails, ring shanks, earring posts, etc. Finish sanding, polishing and/or tumbling your piece.

16. Use a bezel rocker or similar tool to set your stone. Push the bezel over your stone one castellation/serration at a time.

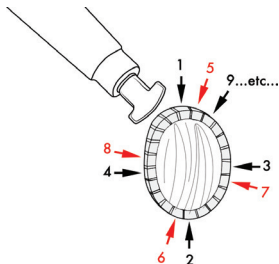

TIP: For best results, start at the top, then move to the bottom and then each side. Continue setting the remaining castellations in a similar fashion.

17. Sand off any tool marks and give your piece one last polish.

18. Enjoy your finished piece!

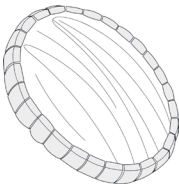

MAINTENANCE AND CARE

Your BezelEase™ device is precision-made from 304 stainless steel. It is designed to be durable and require minimal maintenance.

Clean your BezelEase™ after each session. For the edges, using a toothbrush or compressed air is effective.

If you won't be using your BezelEase™ for a while, store it with a very light coat of oil.

Even stainless steel can oxidize if exposed to high humidity, high salinity (such as sea water), or corrosive fluids or cleaners. If any rust develops, try using a coarse cloth and dish soap or vinegar to remove it. Be careful with abrasive pads or cleaners as aggressive use can damage the surface or embed particulates into the surface. Another method is to soak the parts in an acetic acid (vinegar) solution overnight. Clean the parts and then rinse thoroughly with water.

CONTACT US

For more information and instructional videos, go to BezelEase.com or search for "BezelEase" on YouTube.

FOR SUPPORT: email to support@BezelEase.com

FOR GENERAL INQUIRIES: email to info@BezelEase.com



This document, its contents, and all photographs and illustrations are Copyright © 2021 BezelEase, LLC. All rights reserved.

The BezelEase™ device is U.S. Patent Pending.

BezelEase™ is a trademark of BezelEase, LLC.

Popsicle®, BurLife®, and Boelube® are the property of their respective trademark holders.

BZ202111